

Instruction for Use



| Chrome Wall Shower Filter

T safe

Chrome Wall Shower Filter

Description

The Chrome Wall Shower Filter of the T-safe Pro Water Filtration range is specifically designed to remove bacteria such as, but not limited to, *Legionella pneumophila* and *Pseudomonas aeruginosa* from tap water to prevent infections in commercial and public settings .

T-safe Chrome Wall Shower Filter will effectively retain bacteria for a maximum period of up to 92 days, within the limitations of use as described herein.

This IFU covers the following products:

Item	Code
Chrome Wall Shower Filter	02-803150
Replacement Filter	02-000143
Dummy cartridge	02-000145

Installation of complete unit

Install the product directly from the packaging and ensure that the filter does not come into contact with sources of contamination before being installed.

1

Ensure that the connecting water pipe protrudes a maximum of 16mm from the wall.

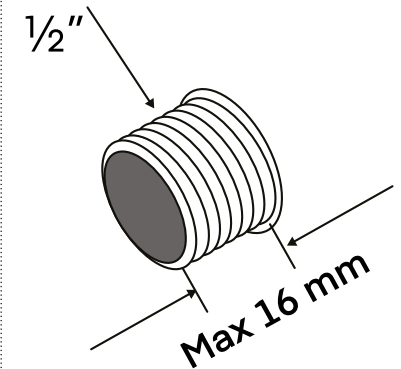

2

Begin by attaching the back plate to the pipe. Then mark the positions on the wall where you intend to drill holes. Once the markings are in place, detach the back plate.

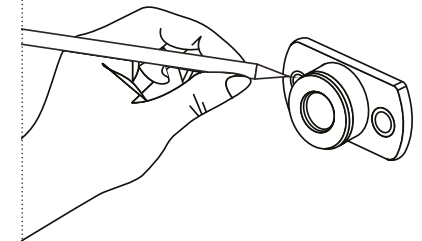

3

Use a $\varnothing 6$ drill bit to create holes at the marked positions on the wall. Insert the provided raw plugs into these holes.

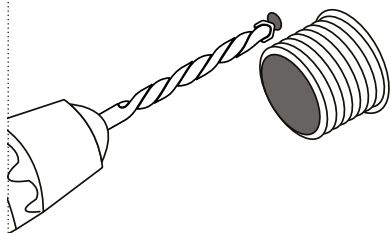

4

To ensure a secure installation, apply an appropriate sealing material around the pipe.

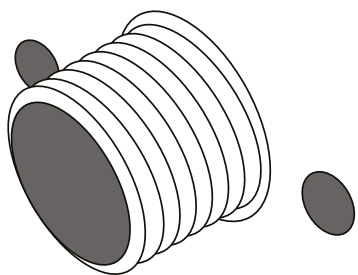

5

Reattach the back plate to the wall, using the screws included with the product.

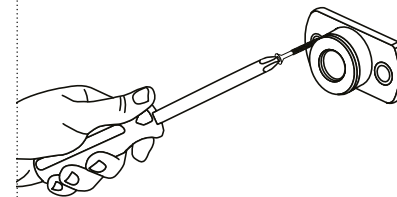

6

Position the showerhead onto the back plate. Push it into place and secure it by tightening the screw located at the top or bottom, depending on the model of the bracket.

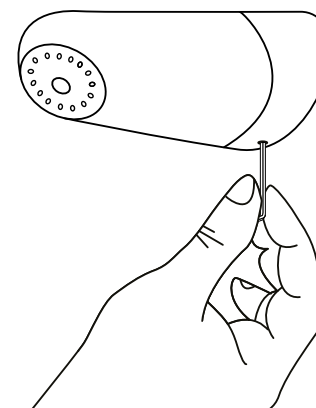

Installation of replacement filter and dummy cartridge

Install the product directly from the packaging and ensure that the filter does not come into contact with sources of contamination before being installed.

1

Begin by releasing the screw located at the bottom or top depending on the model.

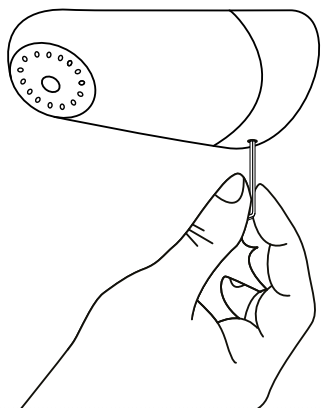

2

To remove the shower head, turn it counter-clockwise while simultaneously releasing and pulling it away.

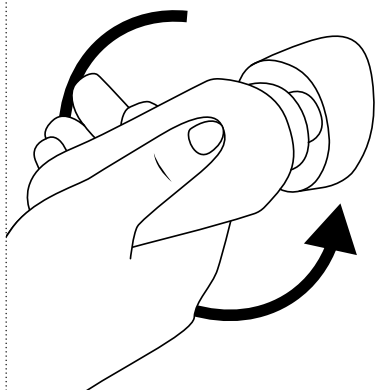

3

Proceed to turn and pull the filter to detach it. Dispose of the filter using normal disposal methods.

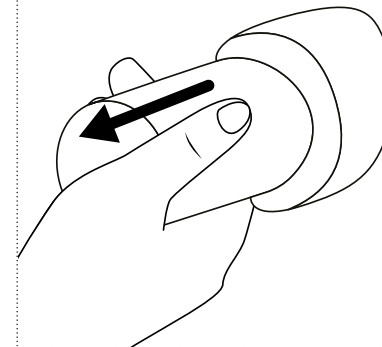

4

Make sure to clean, descale and disinfect the shower head and base in accordance with local guidelines.

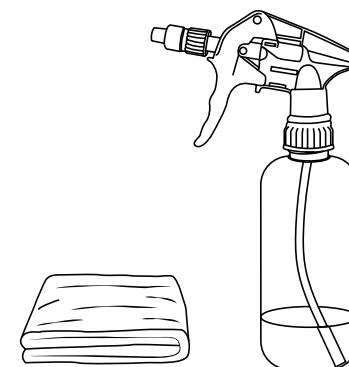

5

Replace the O-ring within the bracket.

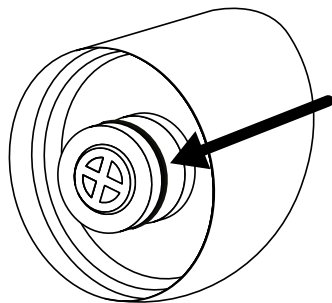

6

Install the new filter by pushing and simultaneously turning it.

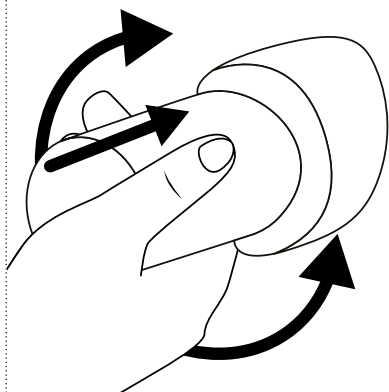

7

Reattach the showerhead to the bracket by turning it clockwise. Secure the showerhead in place by tightening the screw located at the top or bottom, depending on the model.

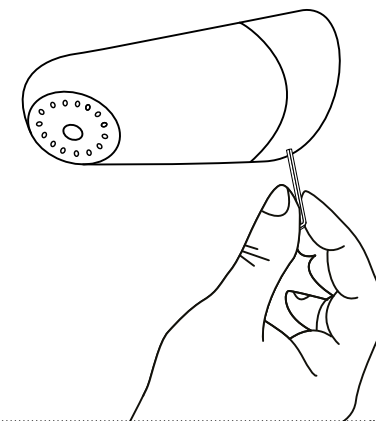

Exposure to Chemical and Thermal Water Treatment

The filter can tolerate the following continuous disinfection treatments:

- 30 ppm chlorine dioxide
- 15 ppm free chlorine (hypochlorite)
- 10 ppm ozone
- 30 ppm hydrogen peroxide
- 10 ppm chloramine

Shock Treatment:

- Up to 1000 ppm free chlorine for 1 hour at room temperature
- pH 12 for 1 hour at room temperature
- 1000 ppm peracetic acid for 2 hours at 60° C

The filter can tolerate thermal disinfection up to 6 times in the lifetime of the filter under the following conditions: 70° C for 5 minutes.

Disposal

The filter cartridge and non-metallic parts can be disposed of with ordinary waste following applicable local regulations under the waste category number 180104 by EU Directive 75/442/EEC.

The lead-free brass metal parts can be cleaned, descaled, and disinfected to be reused with a replacement filter cartridge. When disposing of the metal parts please make sure the items are recycled correctly following local guidelines.

Storage – non-commissioned filter

The product must be stored at temperatures between 5° C and 40° C and at a humidity of max. 60 %. Expiry date: See label on the packaging or marking on the product.

Precautions

- Do not use the filter if the package is open or damaged, or filter is visually damaged
- Do not disconnect the filter during the period of use
- Avoid mechanical impact and do not strike the filter with heavy or metallic objects, as this may damage the filter
- The outlet of the filter should not come into direct contact with skin or hair
- The filter must not be used continuously with water temperatures above 60° C. The optimal working range is 10° C - 45° C
- The filter cannot tolerate pressure above 5 bar
- If the filter is subjected to excessively high water pressure, this will cause the filter to collapse (sudden decrease in water flow). The filter must then be discarded
- The filter cannot be "backwashed"
- The contamination level and the amount of filter-blocking particles and substances in the water might reduce the lifetime of the filter
- The filter cannot be rinsed or cleaned in a dishwasher or autoclave

- The filter must be discarded if the expiry date has passed
- Do not modify or make changes to the filter or the adaptor

NOTE

- Do not use the water for contact lenses
- The quality of the water is not suitable for pharmaceutical use
- The filter will neither alter the taste or odor nor the chemical composition in the water and does not cause any changes in the concentration of salts, metals, lime scale, chemicals, pesticides, and dyes

No liability for misprints or typographical errors.



T-safe A/S

Gydevang 1
3450 Allerød
Denmark

t: +45 48 17 22 82
e: info@t-safe.com

t-safe.com